

* RoHS COMPLIANT *

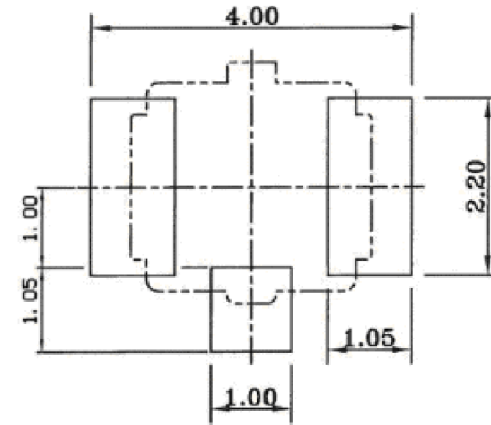

RECOMMENDED PCB LAYOUT

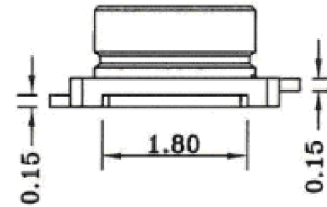
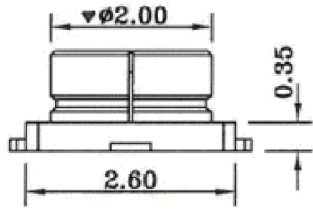
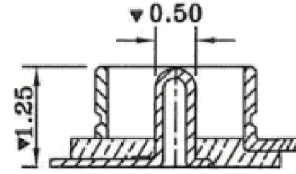
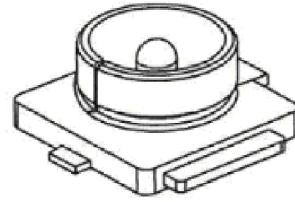
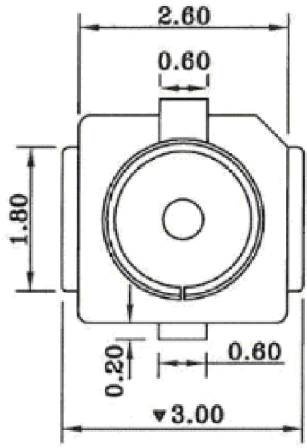
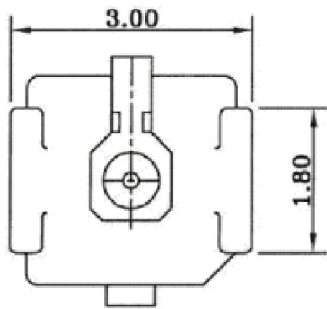

SHEEL	COPPER ALLOY	GOLD FLASH
CONTACT	COPPER ALLOY	GOLD 5u"
HOUSING	LCP UL94 V-0	IVORY
DESCRIPTION	MATERIALS	FINISHED

DWN	LILY	DATE	2013.06.18	3RD ANGLE PROJECTION	NAME	RF HEADER
CHKD	ANDY	DATE	2013.06.18		CAT. NO.	JCRF-39801
APVD	JON	DATE	2013.06.18		UNIT: mm	
JKCR Electronics Co., Ltd.					DWN.NO.	39801
						001

UNLESS OTHERWISE SPECIFIED, TOLERANCE ON DECIMAL: ±0.3